

The logo for ihtsdo, consisting of the lowercase letters 'ihtsdo' in white on a blue square background.

ihtsdo

Leading healthcare  
terminology, worldwide

# SNOMED CT Diagramming Guidelines - International Release (US English)

Latest web browsable version: <http://snomed.org/diaguide>

SNOMED CT Document Library: <http://snomed.org/doc>

Diagramming Guideline .....	3
1 Introduction .....	4
2 Rationale .....	5
3 Diagram Types .....	6
3.1 Expression Diagrams .....	7
3.2 Concept Definition Diagrams .....	8
3.3 Expression Relation Diagrams .....	10
4 Diagram Elements .....	12
4.1 Concepts .....	13
4.2 Attributes .....	13
4.3 Attribute groups .....	13
4.4 Conjunction .....	14
4.5 Relational Operators .....	14
4.6 Arrow .....	14
4.7 Line .....	14
4.8 Names and element sizes .....	15
4.9 Colour .....	15
4.11 Gradients, blends and opacity .....	16
4.12 Fonts .....	16
5 Layout .....	16
6 Examples .....	18
Appendix .....	19
Appendix A - Template Expressions .....	19
Appendix B - Additional Context .....	21
Appendix C - Interactive Browsing Diagrams .....	23
Appendix D - Technical Implementation Guide Examples .....	26

# Diagramming Guideline



Delivering  
**SNOMED CT**

## SNOMED CT Diagramming Guideline

Welcome to the SNOMED CT Diagramming Guideline

This document describes a diagrammatic notation for representing the definition of a concept, an expression, or relation between expressions within SNOMED CT. The aim of this guideline is to:

- Provide a consistent, diagramming style in documentation
- Reduce ambiguity and misunderstandings caused by multiple different representations
- Improve the quality of diagrams through a consistent approach, prompting consideration of all relevant aspects
- Increase efficiency, allowing the SNOMED CT community to rapidly exchange ideas
- Reduce effort by providing templates supporting commonly used tools

This guideline is for use in all IHTSDO documentation and is strongly recommended for all other documentation representing SNOMED CT concepts and models.

Latest web browsable version: [Diagramming Guideline](#)

SNOMED CT Document Library: <http://snomed.org/doc>

Publication date: 2016-08-13

This is the date when this PDF file was generated from the online version of this document.

© Copyright 2016 International Health Terminology Standards Development Organisation (IHTSDO), all rights reserved. This document is a publication of the International Health Terminology Standards Development Organisation (IHTSDO), the association that owns and maintains SNOMED Clinical Terms.

Any modification of this document (including without limitation the removal or modification of this notice) is prohibited without the express written permission of the IHTSDO. This document is subject to regular updates. Always use the latest version of this document published by IHTSDO. This can be viewed online and downloaded by following the links on the front page or cover of this document.

SNOMED, SNOMED CT and IHTSDO are registered trademarks of the International Health Standards Development Organisation. SNOMED CT licensing information is available at <http://snomed.org/licensing>. For more information about IHTSDO and IHTSDO Membership, please refer to <http://www.ihtsdo.org> or contact us at [info@ihtsdo.org](mailto:info@ihtsdo.org).



# 1 Introduction

## Purpose

This document describes a diagrammatic notation for representing the definition of a concept, an expression, or relation between expressions within SNOMED CT. The aim of this guideline is to:

- Provide a consistent, diagramming style in documentation
- Reduce ambiguity and misunderstandings caused by multiple different representations
- Improve the quality of diagrams through a consistent approach, prompting consideration of all relevant aspects
- Increase efficiency, allowing the SNOMED CT community to rapidly exchange ideas
- Reduce effort by providing templates supporting commonly used tools

This guideline is for use in all IHTSDO documentation and is strongly recommended for all other documentation representing SNOMED CT concepts and models.

Alongside this document, templates for Visio, Omni Graffle and PowerPoint are also published.

## Who Should Read This Specification?

The intended audience for this document includes members of the SNOMED CT community of practice who wish to diagrammatically represent a SNOMED CT concept or expression.

## Related Documents

Name	Location
SNOMED CT Technical Implementation Guide	<a href="http://snomed.org/tig">http://snomed.org/tig</a>
SNOMED CT Glossary	<a href="http://snomed.org/gl">http://snomed.org/gl</a>
SNOMED CT Compositional Grammar	<a href="http://snomed.org/scg">http://snomed.org/scg</a>



## 2 Rationale

This document defines a recommended form for diagrams representing SNOMED CT concepts.

Historically these diagrams have been created using ad hoc diagramming techniques and styles to express the author's thoughts.

Approaches have included borrowing from UML notation and other diagramming standards. However using ad hoc techniques have resulted in

- Confusion and misinterpretation
  - particularly when applying adapted forms of existing standards such as UML where the reader misinterprets the diagram due to their knowledge of the underpinning standard
- Errors and omissions
  - different diagramming techniques require varying levels of detail, some of which do not force the author to think through all aspects of the idea they wish to express
- Inefficiency
  - having a variety of diagrammatic forms requires more effort and time for the reader to interpret
  - creation of a new diagramming form, or selection from many in use and undocumented forms requires more effort and time from the diagram author
  - creation of diagrams by many different people without tooling support such as diagram templates wastes authoring time
- An inconsistent look and feel for IHTSDO documents

In order to address these issues, a diagramming guideline has been created and is presented in this document. The aim of this guideline is to aid a clear, efficient and consistent method of communication for the SNOMED CT community of practice.

### 3 Diagram Types

The diagramming notation described in this document can be used to represent three types of information

- Expressions
- Concept definitions
- Expression relations

These different types of diagram are described in the following sections in detail, although they have the three different forms as shown below.

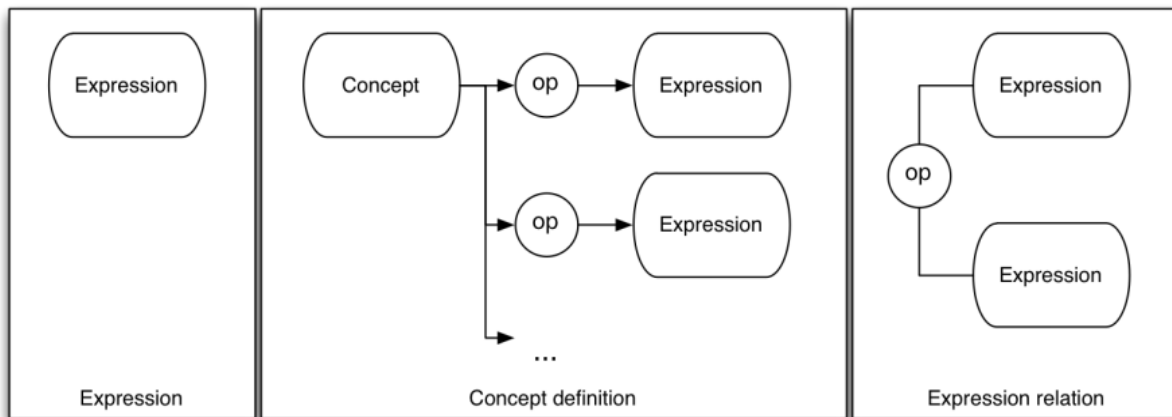

Figure 1 Types of diagram  
Note that in the diagram above

- the elements labelled "Expression" are meant to represent expressions defined in the "Expression" diagram type (see 3.1).
- the element labelled "Concept" is a concept element as defined in section 4.1
- the "op" element represents a relational operator as defined in section 4.5

Within this document "expression" refers to SNOMED CT expressions, which are A structured combination of one or more concept identifiers used to express an instance of a clinical idea. Each expression is composed of sub parts, which are often expressions in their own right, with a single concept value being the simplest type of expression. An "Expression Diagram" represents an expression value and is equivalent to a SNOMED CT expression. A "Concept Definition Diagram" is a series of statements defining a concept using one or more expressions to make these statements. An "Expression Relation Diagram" shows how the values of two expressions relate to one another.

It is also worth noting that the current SNOMED CT Compositional Grammar<sup>1</sup> only has sufficient features to represent the left most diagram type – Expressions as defined in section 3.1. However the ability to represent the definition of a concept in terms of an expression, or show the relationship between two expressions, is useful in diagramming even though it may never be useful or included in the SNOMED CT Compositional Grammar.

For this reason the diagramming guideline has been permitted to extend beyond the notation in the SNOMED CT Compositional Grammar for these two use cases. Aside from these cases the diagramming guideline will remain synchronized with the capabilities of the SNOMED CT Compositional Grammar.

Generally diagrams may be in one of the normal forms (short, long or distribution), or in stated form (for definitions) or close-to-user form (for expressions). To clearly indicate that a diagram represents a particular form it should be labelled as such. Future versions of the Diagramming Guideline may include specific additional notation to indicate a diagram's form.

Finally a fourth use case not formally covered in this document is interactive browsing diagrams rendered by software for navigating SNOMED CT content. While not currently formally covered in this document, Appendix C - Interactive browsing diagrams does explore this use case and options for future inclusion.

<sup>1</sup> The latest version of the SNOMED CT Compositional Grammar is available at <http://snomed.org/scg>.

### 3.1 Expression Diagrams

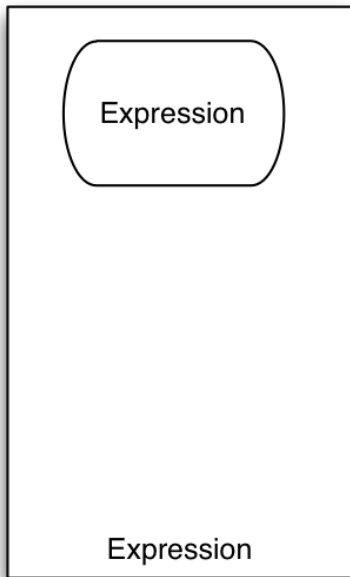

Figure 2 Simple expression diagram

Expression diagrams are the most general form of diagram, which represent a SNOMED CT expression as defined in the SNOMED CT Compositional Grammar. Diagrams representing expressions may exist on their own, or be part of a larger diagram representing a concept definition or relation between two expressions. In its simplest form this may simply be a single concept

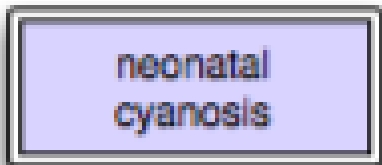

Figure 3 Diagram of the single concept 95617006 |Neonatal cyanosis|

In more complex scenarios diagrams may represent coordination of attribute types and concepts.

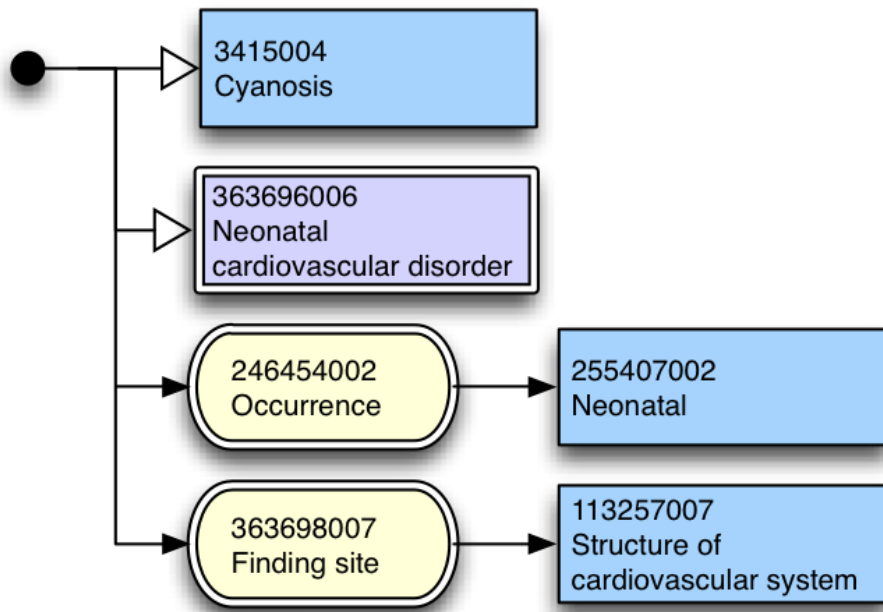

Figure 4 Expression equivalent<sup>1</sup> to 95617006 |Neonatal cyanosis|  
 In all expressions other than a single concept value<sup>2</sup> it is necessary to start the diagram with a conjunction dot.

<sup>1</sup> Equivalent as at the January 2012 SNOMED CT International release.

<sup>2</sup> An example of an expression is shown in Figure 4, whereas a single concept value is shown in Figure 3

### 3.2 Concept Definition Diagrams

A more specific use of the diagramming notation is to represent the definition of a concept. This consists of

- the concept whose definition is being shown at the top left,
- connected to a series of one or more relational operators to an expression.



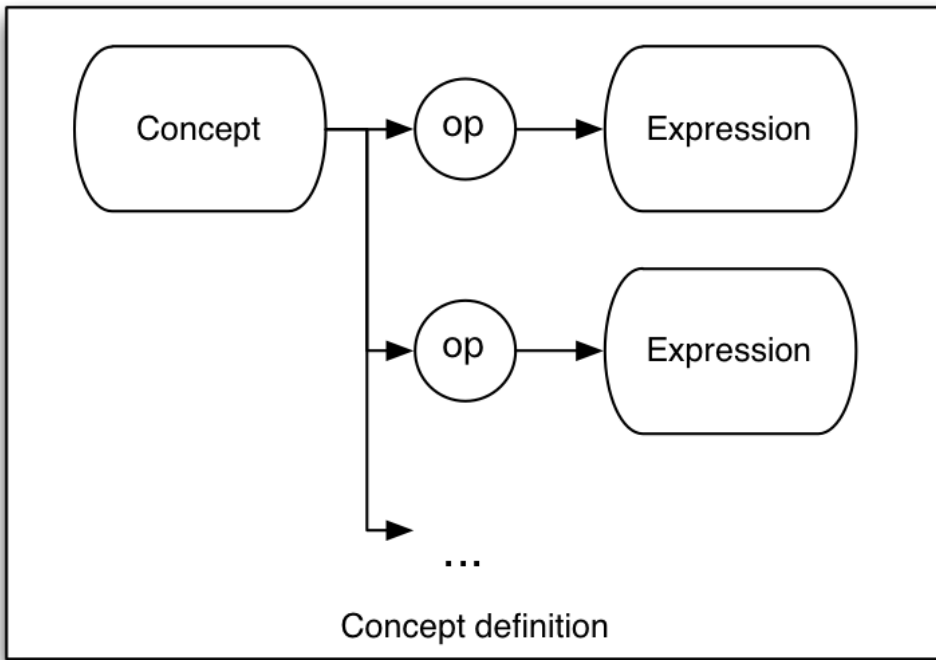

Figure 5 Concept definition diagram

In all cases a concept definition should be complete. That is, they should include all defining attributes. This can be used to represent "fully defined" concepts as follows:

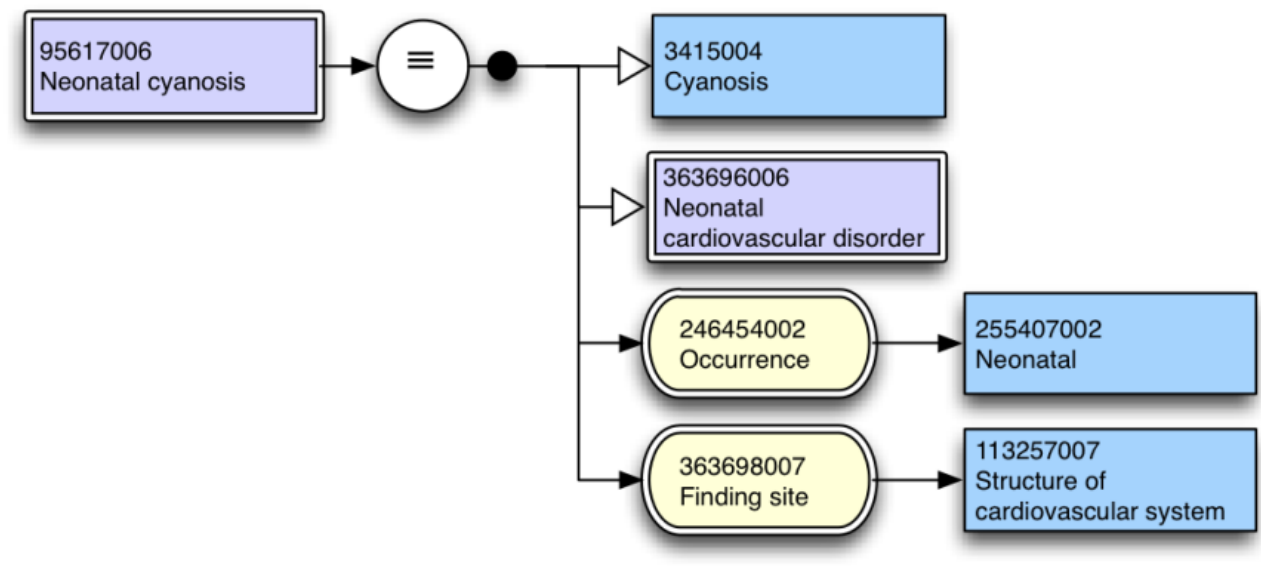

Figure 6 Diagram of a fully defined concept

Primitive concepts may be represented as follows:

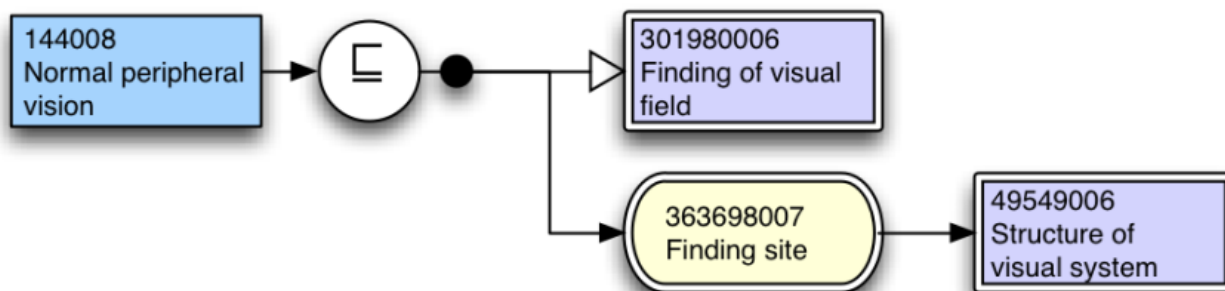

Figure 7 Primitive concept definition

The relationship between a concept and multiple expressions may also be represented, and in this manner multiple sets of attributes may be expressed.

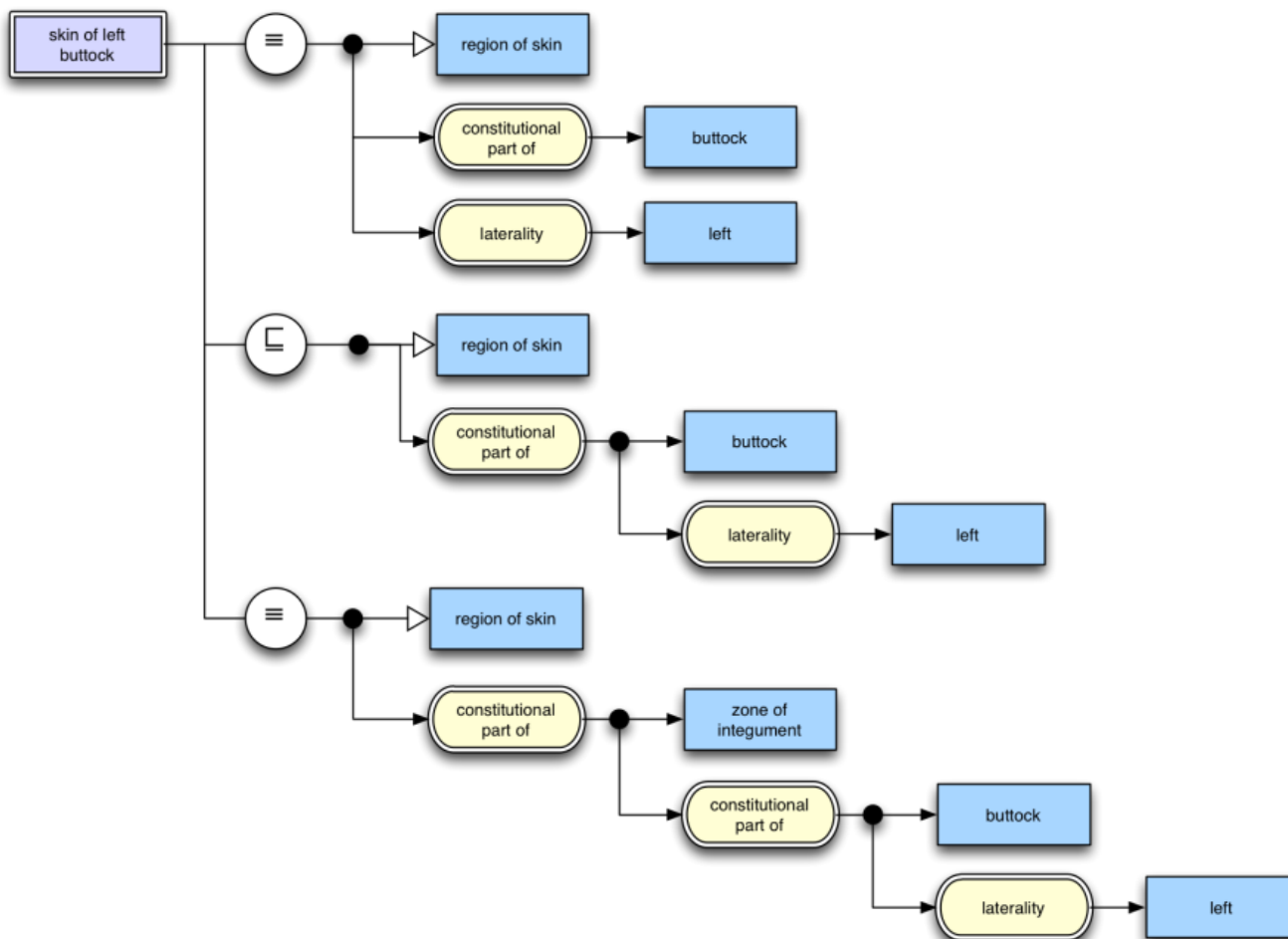

Figure 8 Concept definition including multiple sets in close to user form

Expressing multiple sufficient sets is not currently supported in SNOMED CT distribution content, however it may be in future, and regardless has utility in the diagramming notation and for this reason has been included.

### 3.3 Expression Relation Diagrams

The diagramming notation described in this document can also be used to describe the relationship between two different SNOMED CT expressions.

This is represented by two expression diagrams, one above the other, separated by a relational operator between. The diagram is read top to bottom.

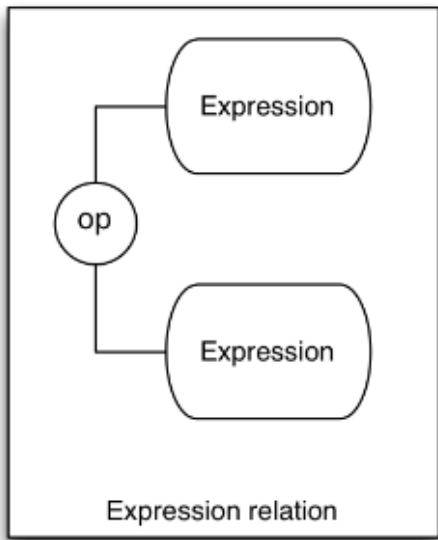

Figure 9 Expression relation diagram  
 As an example below is a diagram showing two expressions that are equivalent:

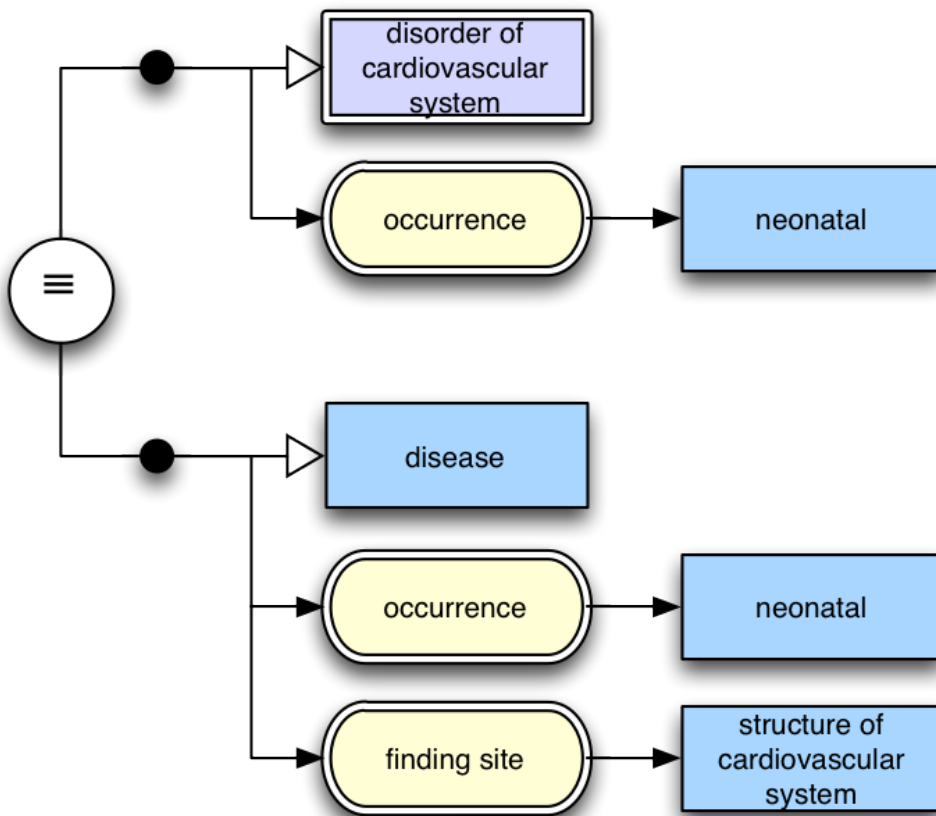

Figure 10 Diagram showing equivalence of two expressions  
 Note that in this example the equivalence relation connects the two expressions with lines – indicating that the relationship is bidirectional and can be read either way.

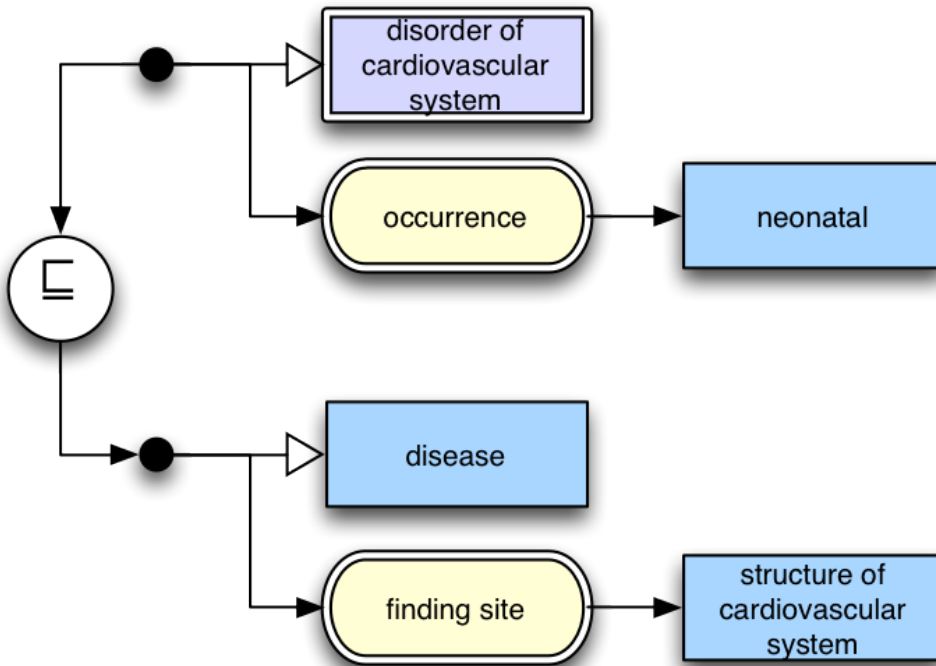

Figure 11 Diagram showing an expression subsumed by and other expression  
 Figure 11 shows an expression (top) subsumed by another expression (bottom). Note that arrows have been used to connect the expressions to the relational operator to indicate the direction it must be read.

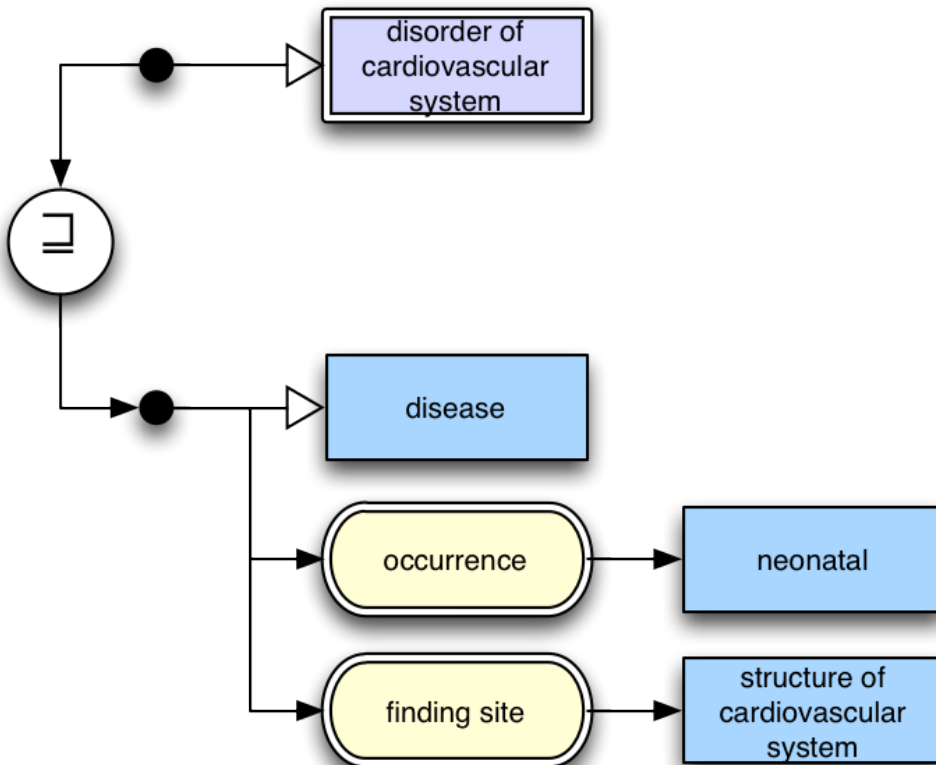

Figure 12 Diagram showing an expression that subsumes another expression  
 Figure 12 shows an expression (top) that subsumes an expression (bottom). Again note arrows have been used to indicate the direction this relationship must be read.

## 4 Diagram Elements

This section describes the elements of the diagramming notation, including their shape/style and colour if applicable.

---

### 4.1 Concepts

Concepts are represented by a rectangle, containing the name of the concept as shown below.

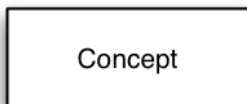

Figure 13 concept element

The name used must be the concept's fully specified name or a synonym.

Optionally the definition status of a concept may be represented. Concepts that are fully defined may be represented using a double line border as shown below:

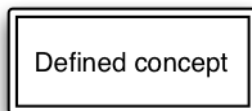

Figure 14 defined concept element

A rectangle with a single border is assumed to be primitive unless explicitly noted otherwise or it is clear in context (e.g., diagramming during a whiteboard discussion).

---

### 4.2 Attributes

Relationships, or attributes, are represented using a rectangle with rounded ends and a double line border, as shown below:

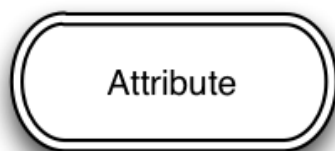

Figure 15 attribute element

A rounded rectangle with a single border is permitted in informal contexts (e.g., diagramming during a whiteboard discussion).

#### "Is A" Arrows

"Is a" (subtype) relationships are highlighted by using an open-headed arrow as shown below:

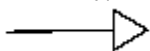

Figure 16 "Is a" element

The rounded rectangle specified in section 4.2 is omitted when representing "Is a" relationships, and the arrow head always points to the parent (super-type) concept.

---

### 4.3 Attribute groups

Attribute groups are represented with a circle:

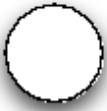

Figure 17 attribute group element

## 4.4 Conjunction

A conjunction is represented with a black "dot" (black filled small circle). It is only necessary when two or more attributes are being joined in a diagram. It is optional when attaching a single attribute.



Figure 18 conjunction element

## 4.5 Relational Operators

Relational operators may be represented between expressions using the following notation:



Figure 19 Equivalent



Figure 20 Subsumed by



Figure 21 Subsumes

Note that the characters  $\supseteq$  and  $\subseteq$  are not present in all fonts. For users of Microsoft tools these characters can be found in the "Arial Unicode MS" font.

## 4.6 Arrow

An arrow as shown below is used to connect related elements where the connection is unidirectional:

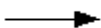

Figure 22 arrow

Connecting arrows always have an arrow head at one end, and therefore have an explicit direction from one element to another the direction the diagram should be read.

## 4.7 Line

Similar to the Arrow in section 4.6, the Line shown below is used to connect elements in the diagram where the connection is bi-directional:

Figure 23 line

---

## 4.8 Names and element sizes

Each element contains a name as specified. The diagram elements may be resized and/or the text of the name given to the element may be wrapped as needed to achieve readability. When resizing it is highly recommended that concept and attribute elements remain rectangular and wider than they are tall where possible.

Names chosen must be fully specified names or (usually preferred) synonyms as stated, however a single diagram must consistently use either fully specified names or synonyms for all diagram elements.

It is highly recommended that an element's name be preceded by its concept identifier. This is to eliminate any potential ambiguity.

---

## 4.9 Colour

Diagrams may be produced in black and white, or colour may be added to aid readability.

In order to provide consistency the following sections specify the colours to be used for each type of element. Specified colours are websafe, do not affect black and white printing and are generally perceptible by most common colour blindness.

### Concepts

Primitive concepts are coloured with RGB 99CCFF (decimal 153, 204, 255) as shown below.

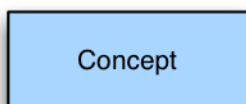

Defined concepts are coloured with RGB CCCCFF (decimal 204, 204, 255) as shown below.

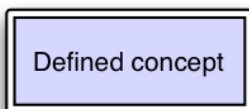

### Attributes

Attributes are coloured with RGB FFFFCC (decimal 255, 255, 204) as shown below.

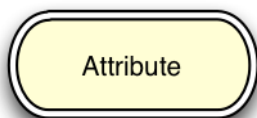

### Attribute groups

Attribute groups are not coloured, and are always presented as a circle with a white interior.

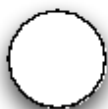

### Conjunctions

Conjunctions are not coloured, and are always presented as a black dot as shown in 4.4.

### Relational Operators

Relational operators are not coloured and are always represented as shown in 4.5.

---

## 4.11 Gradients, blends and opacity

Graded shading provided by modern diagramming tools are NOT permitted as they

- Can vary substantially in style
- May reduce readability and consistency.

For example the following are not acceptable.

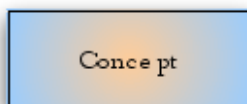
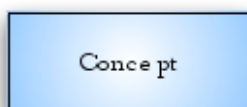

---

## 4.12 Fonts

For consistency, all text within diagram elements are to use a sans-serif font such as "Helvetica"<sup>1</sup> and font size is to be consistent across all elements within a single diagram.

Authors are also strongly encouraged to keep the apparent size of the text in the final image close to that of the surrounding text (usually 8-12 points).

<sup>1</sup> See <http://en.wikipedia.org/wiki/Helvetica>

## 5 Layout

Diagrams are laid out and read top to bottom, left to right.

Orthogonal lines are used to connect elements; arrowheads, located on the end of lines pointing away from the line centre, indicate the direction to read the diagram.

Lines are preferred to run left to right, top to bottom, however other orientations are acceptable when required. Lines emanate from and connect to diagram elements at the top, bottom, left and right sides of the elements.

Attributes (rounded rectangles) must always have two lines connected to them, one with its arrowhead pointing at the attribute, the other with its arrowhead pointing at the concept that is the target of the attribute.

Where a single concept must appear multiple times on a diagram, authors are strongly encouraged to use SNOMED CT IDs and/or Fully Specified Names on the diagram to remove potential ambiguity. It is possible to render only one box per unique concept and connect multiple lines into that concept/s, however this is discouraged as it is likely to create difficult routing for lines and consequently poor readability.



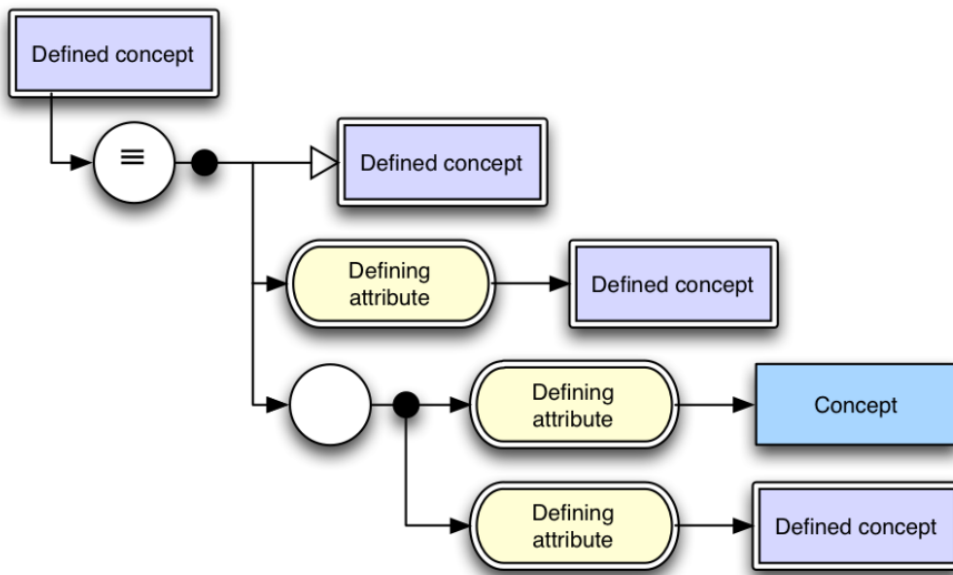

Figure 24 - Diagram layout example

The elements should be ordered as follows, top to bottom:

1. "Is-a" supertypes,
2. ungrouped attributes,
3. grouped attributes.

For finer grained ordering of relationships, the sort order defined in the Technical Implementation Guide should be used.

## 6 Examples

This section shows some example uses, diagramming existing content from SNOMED CT.

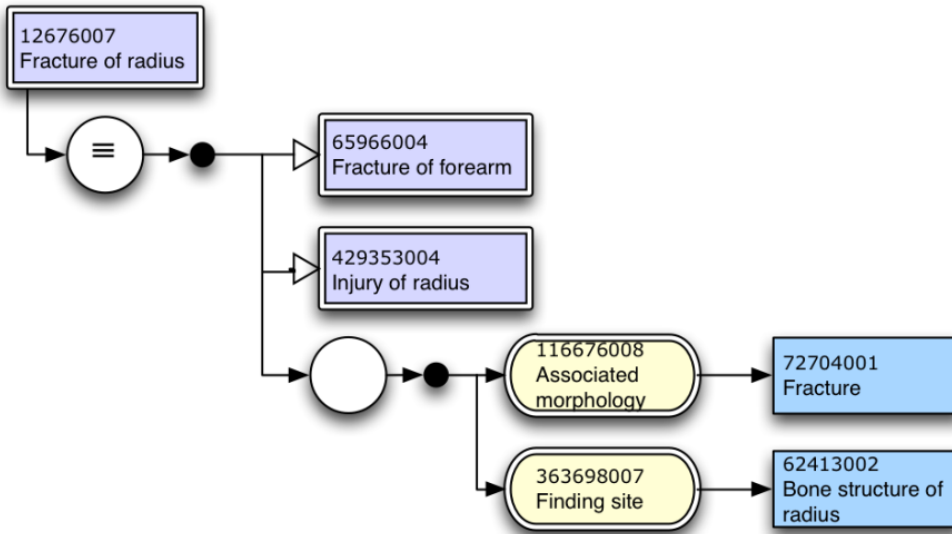

Figure 25–Definition of 12676007 |Fracture of radius| in distribution normal form including identifiers

The concept definition shown in Figure 25 shows that the concept 12676007 |Fracture of radius| is equivalent to the following distribution normal form expression -

```
429353004 |Injury of radius| + 65966004 |Fracture of forearm| :
{ 116676008 |Associated morphology| = 72704001 |Fracture| ,
  363698007 |Finding site| = 62413002 |Bone structure of radius| }
```

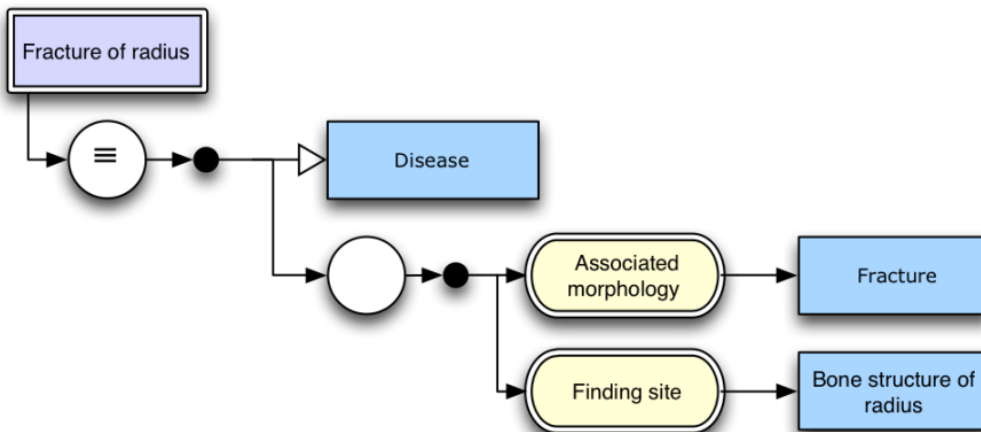

Figure 26–Definition of 12676007 |Fracture of radius| in long normal form without identifiers

Figure 26 shows the definition of 12676007 |Fracture of radius| again, however this time in long normal form and without identifiers.

The expression on the right hand side of the diagram equates to the text expression -

```
64572001 |Disease| :
{ 116676008 |Associated morphology| = 72704001 |Fracture| ,
  363698007 |Finding site| = 62413002 |Bone structure of radius| }
```

## Appendix

- Appendix A - Template Expressions
- Appendix B - Additional Context
- Appendix C - Interactive Browsing Diagrams
- Appendix D - Technical Implementation Guide Examples

### Appendix A - Template Expressions

This appendix describes potential future changes designed to support template expressions. That is, expressions with predefined variables which when assigned values populate the expression.

As these are potential future extensions, this section is not a normative part of this document. It exists to gather feedback on proposed handling of template expressions. Once appropriate extensions are made to the SNOMED CT Compositional Grammar to support template extensions this section will be updated with feedback and moved to the normative part of this document.

#### Slots

For diagrams representing a template expression or definition, it is possible to represent "slots" which represent a placeholder a concept can fill when the template is used (see A.3). Slots are expressed using a parallelogram as shown below. The name of the slot can be considered like a variable for replacement and is surrounded by angle brackets "<" and ">".



#### Color for Slots

Slots as described in section A.1 are optionally coloured with RGB FF9999 (decimal 255, 153, 153) as shown below:



#### Concept Definition Template Diagrams

Using the "slot" element described in A.1 it is possible to define diagrams that represent a template for concept definition or expressions. It is then possible to use this template to create concepts or expressions by filling the "slots" with appropriate concepts.

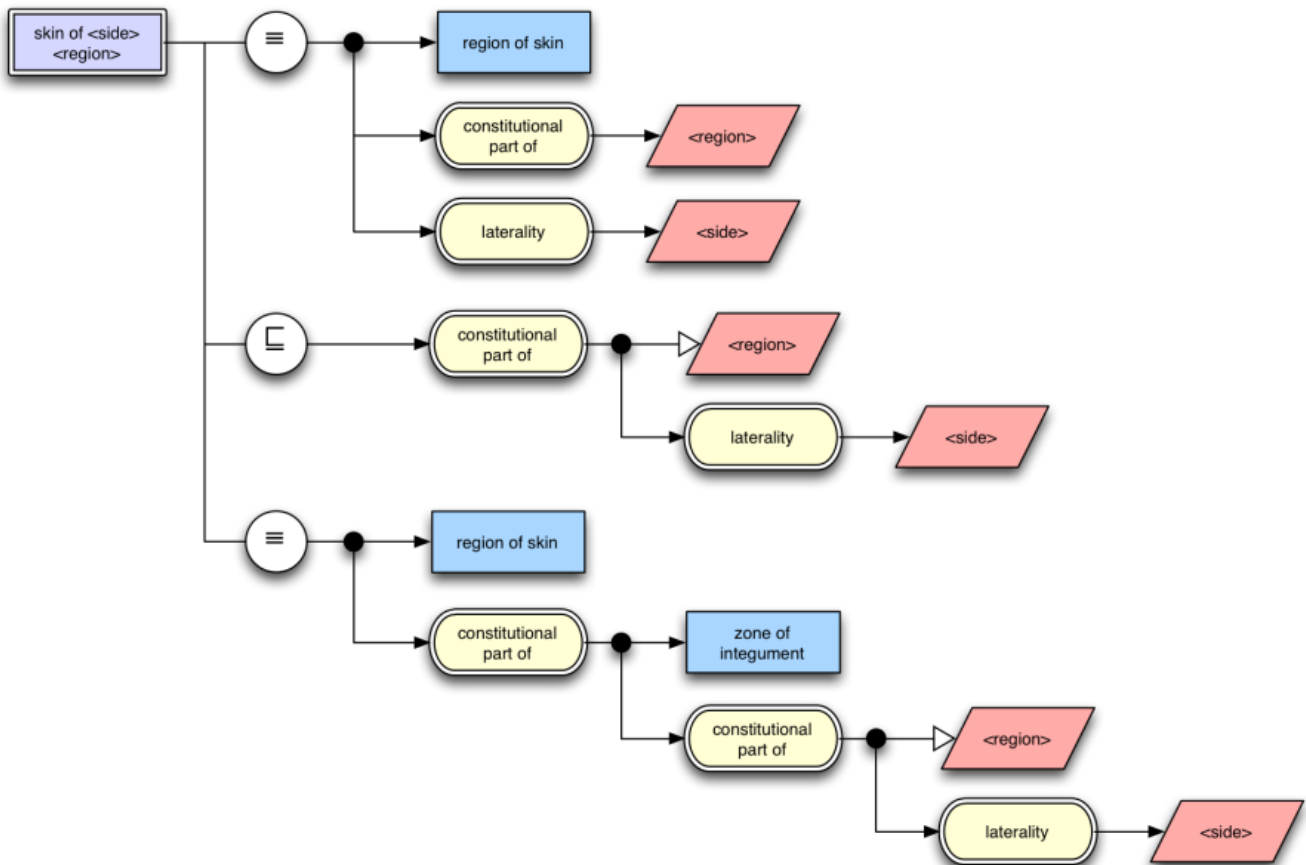

Figure 27 Example template diagram using "slots"

These template diagrams are a specialisation of concept definition diagrams as described in section 3.2; however some of the attribute value concepts are replaced by "slots" making the definition general and reusable.

Note the names provided for the "slots" are enclosed in angle brackets "<" and ">". These slot names are inserted into the name of the concept in the top left of the diagram.

The names associated with slots operate as unique variable names for a diagram or set of diagrams. When populated, every slot with the same name on a diagram, or set of related diagrams, receives the same concept value associated with that slot name. Unless all slots names used are assigned concept values, the expression is not complete.

## Appendix B - Additional Context

Earlier versions of the Diagramming Guideline included a section on providing additional context for concepts in diagrams - that is expanding concepts on diagrams to provide further information or context to a diagram.

These approaches, while potentially useful, also increase complexity and introduce the possibility of ambiguity and misinterpretation, and have therefore been omitted from the Diagramming Guideline. Feedback from readers is sought for future versions of the Diagramming Guideline, at present this appendix includes the two forms of additional context previously proposed to elicit feedback.

### Concept Parents

A concepts parents may be added to a diagram for context using "Is a" relationships as shown in section 4.2.1. For example in the following diagram the parents of 6596004 | Fracture of forearm | have been added as extra context:

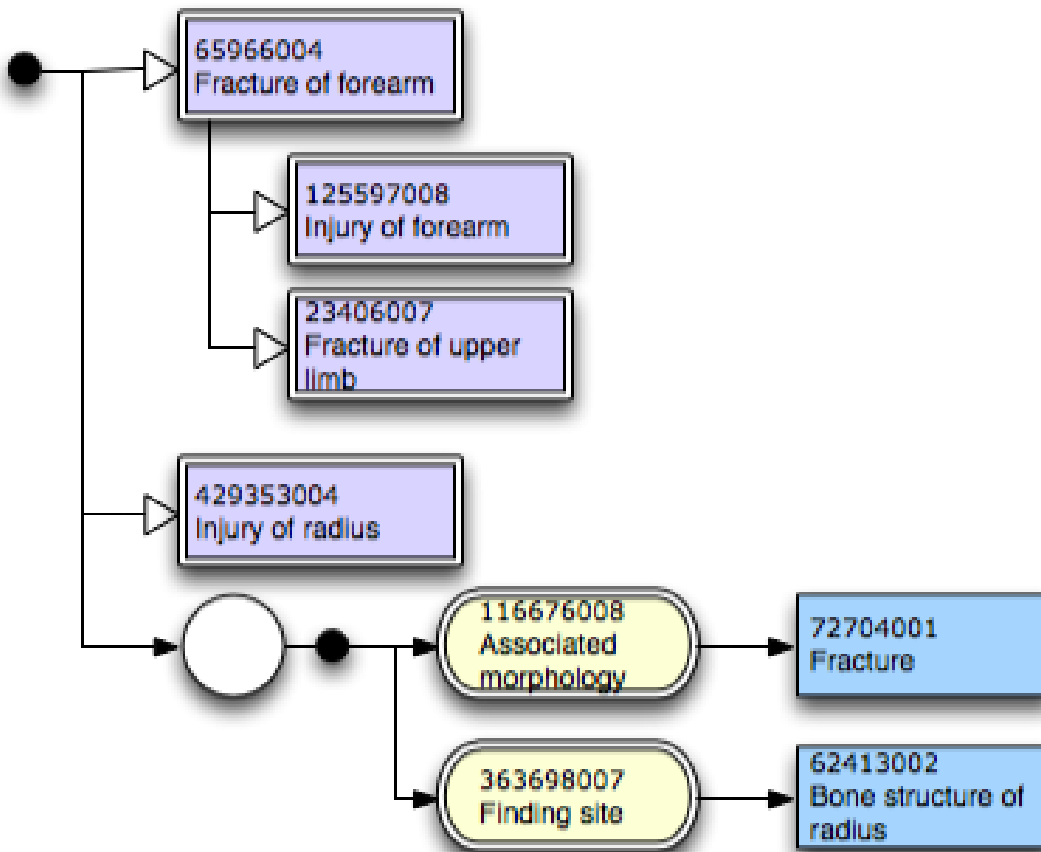

Figure 28 expression showing an included concept's parent concepts as context

Note that this in no way changes the meaning of the diagram, which represents the expression

429353004 |Injury of radius| + 6596004 |Fracture of forearm| :

{ 116676008 |Associated morphology| = 72704001 |Fracture| ,  
363698007 |Finding site| = 62413002 |Bone structure of radius| }

### Full Concept Definition

The full definition of a concept may be added to the diagram to provide additional context for readers. Below is a diagram of the same expression used in section B.1, however this time the full definition of 6596004 | Fracture of forearm | has been provided:

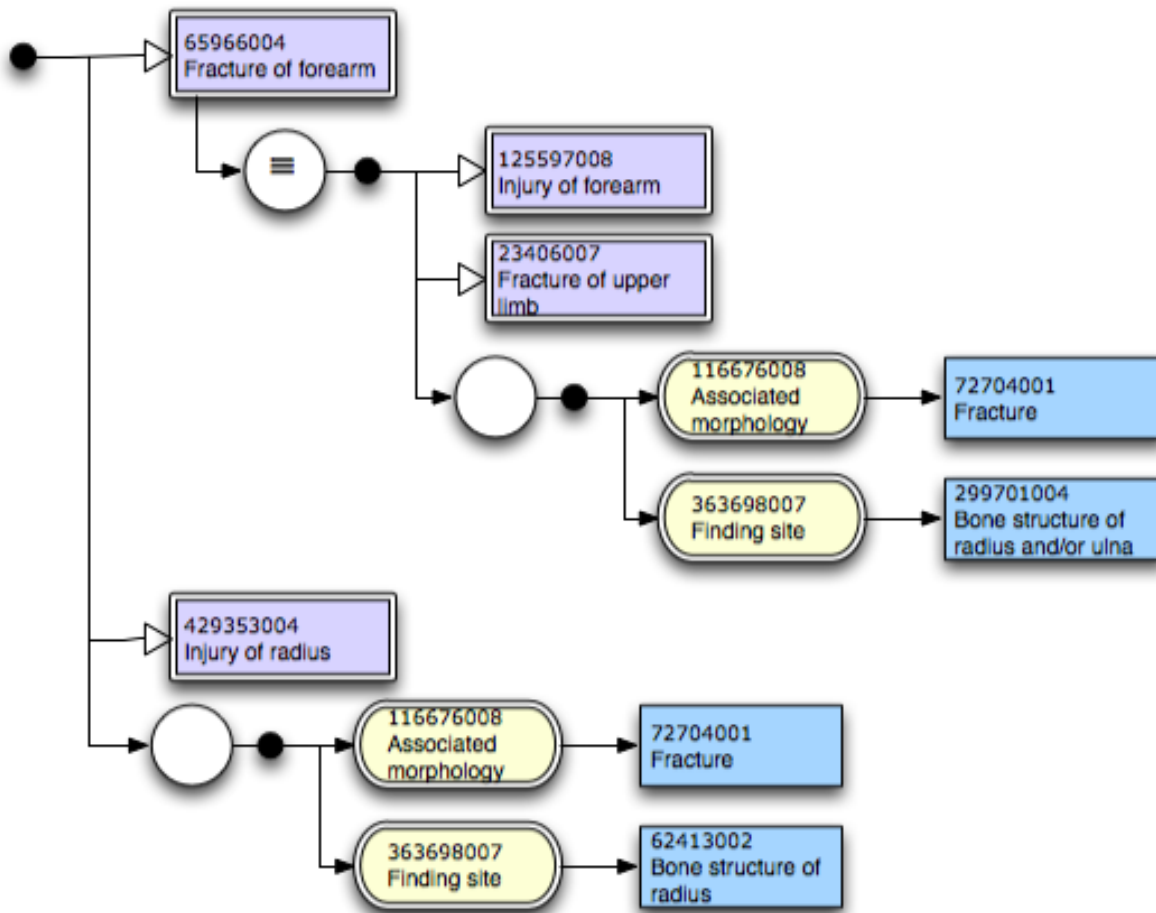

Figure 29 expression showing an included concept's definition as context

### Clarifying Additional Context

A further suggested visual clarification to either approach specified in sections B.1 and B.2 is to use

- a dotted/dashed box around the segments of the diagram providing "additional context"
- and/or change connectors in segments reflecting "additional context" to use dotted or dashed lines

Is a complementary, not a competing, proposal to those specified in sections B.1 and B.2.

## Appendix C - Interactive Browsing Diagrams

Section 3 explores three different forms of diagram for expressing

- Expressions
- Concept definition
- Expression relation

This appendix explores a fourth type of diagram, essentially an extended use of the "Concept definition" diagram for use specifically in rendering interactive diagrams to navigate and explore SNOMED CT content.

This specific case is not included in the formal Diagramming Guideline at present, as it requires further exploration to be specified. However it may also be determined that there are multiple differing renderings that are useful in different browsing scenarios, and therefore one or a finite number of diagram styles may not be possible to define.

The following sections and examples are intended to demonstrate alternate layouts useful for browsing use cases, in an effort to elicit feedback and explore this scenario.

### Abbreviated concept definition

Figure 30 depicts a concept definition diagram as used in the Workbench Utilities at the time of writing.

The most distinguishing feature of this approach is the removal of the "equivalence" symbol as an abbreviation. This enables the concept's parents to appear above the "concept in focus" while attributes appear on the right without excess clutter (as depicted in Figure 31).

Note that this diagram also includes child concepts of the "concept in focus" below, and attributes of which the "concept in focus" is a target on the left. This results in

- The arrows emanating from the "concept in focus" showing the definition of the "concept in focus"
- The arrows entering the "concept in focus" showing where the "concept in focus" is used in the definition of other concepts.

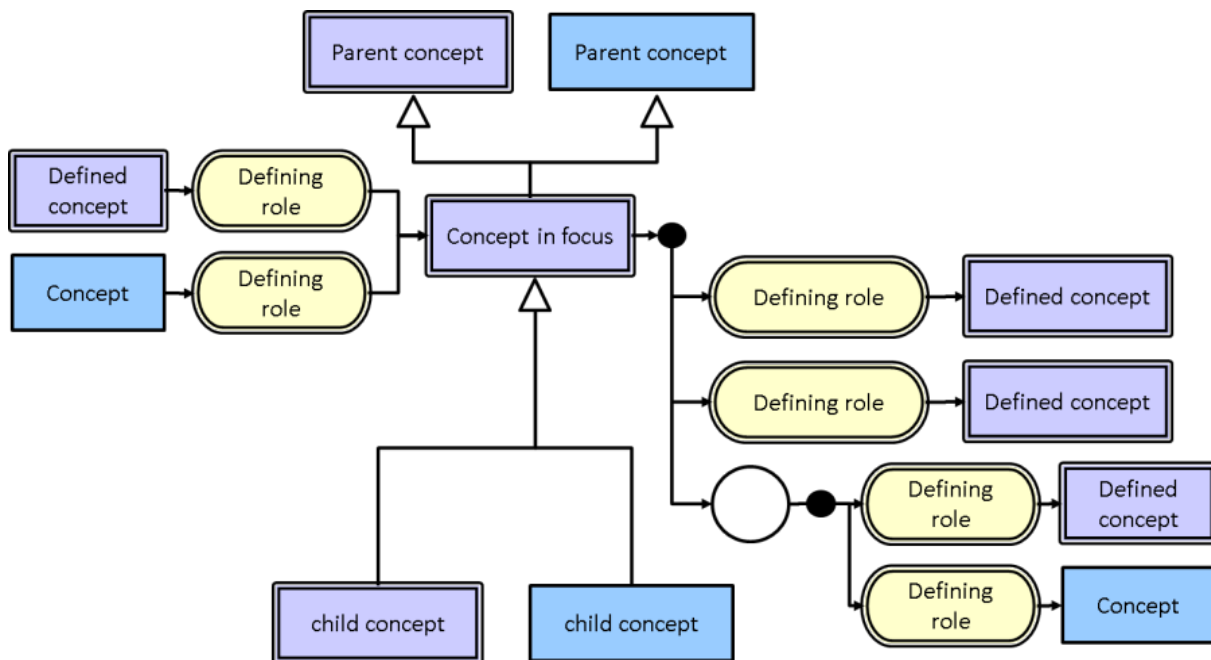

Figure 30 abbreviated browsing concept definition diagram

### Unabbreviated concept definition

Figure 31 depicts an alternate representation to that shown in Figure 30, where the "equivalence" symbol has not been abbreviated.

This approach is it conforms to the concept definition form in section 3.2; however it does present a more cluttered diagram than the abbreviated form in Figure 30.

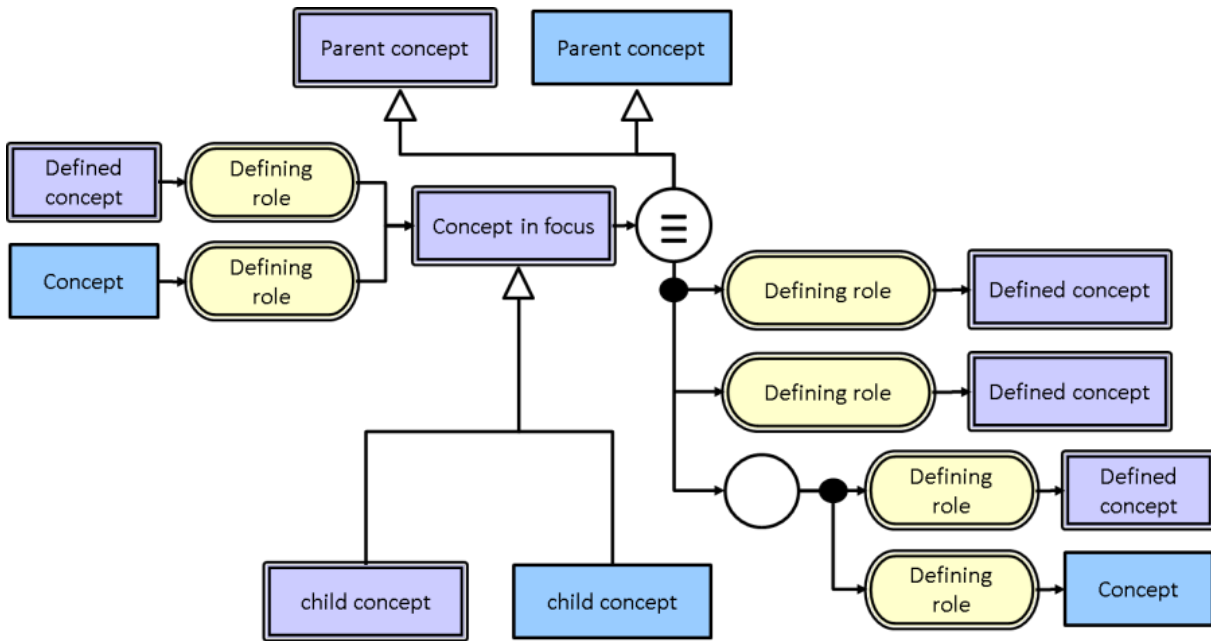

Figure 31 unabbreviated browsing concept definition diagram

### Alternative Unabbreviated Concept Definition Layout

Figure 32 shows an alternative layout of Figure 31. This layout uses the same layout used in 3.2 for the definition of the "concept in focus" - parent concepts shown on the right hand side. This matches the representation in 3.2, and achieves more space for rendering where the "concept in focus" is used in the definition of other concepts. However the resulting diagram is less intuitive than displaying the focus concept's parents above the focus concept.

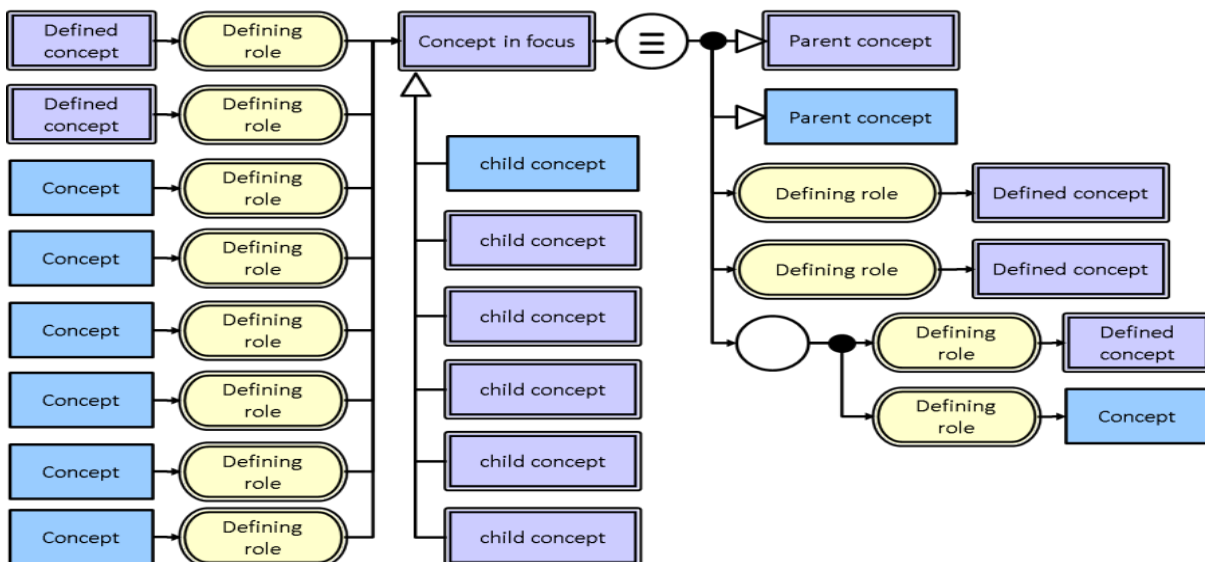

Figure 32 alternative unabbreviated browsing concept definition diagram

### Alternative Views

The diagram options in this appendix have been largely focussed on a concept definition centric interaction/navigation; however there are other focuses that may also be useful. For example it is common to consider browsing or navigating SNOMED CT purely from its sub/supertype relationships in a full hierarchical view back to the root node. While the examples in this section do provide immediate parents, sometimes hierarchical views showing full lineage are useful. However given the real-estate requirements of full lineage and full concept definition, it is unlikely that both renderings can coexist on the same diagram concurrently. Consequently an alternate style may be required for this view, of which





there are many examples in SNOMED CT browsers at present.

Another example scenario is browsing a reference set/s or SNOMED CT content in context of a reference set/s. Again this use case is likely sufficiently at odds with the examples provided in this appendix that an alternate diagram style is required.

As this Diagramming Guideline is focussed on expressions and concept definitions, these and other potential views are out of scope and as yet unexplored formally by this document. Many examples of these renderings exist in the numerous SNOMED CT browsers, and may be left unspecified for the continued innovation of browser vendors, or explored in future versions of the Diagramming Guidelines if considered worthwhile.

## Appendix D - Technical Implementation Guide Examples

The following diagrams show examples taken from the SNOMED CT Technical Implementation Guide January 2013, redrawn using the notation specified in this document. If approved it is anticipated that the diagrams in the SNOMED CT Technical Implementation Guide would be replaced by the examples shown in this section.

For convenience the figure number and original diagram from the SNOMED CT Technical Implementation Guide have been included in this section.

Note that the diagrams drawn in this section are an exact copy of the diagrams from the SNOMED CT Technical Implementation Guide as at January 2013. Some of the concepts represented in the diagrams do not appear in the actual SNOMED CT January 2013 content; however this has been faithfully copied from the current diagrams in the SNOMED CT Technical Implementation Guide.

Figure 21: Refining a concept to add specificity from the SNOMED CT Technical Implementation Guide section 4.2.2.3.3

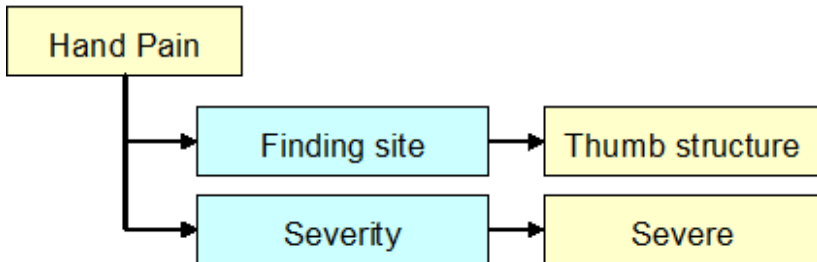

Figure 33 SNOMED CT TIG section 4.2.2.3.3 Figure 21  
Would be redrawn as

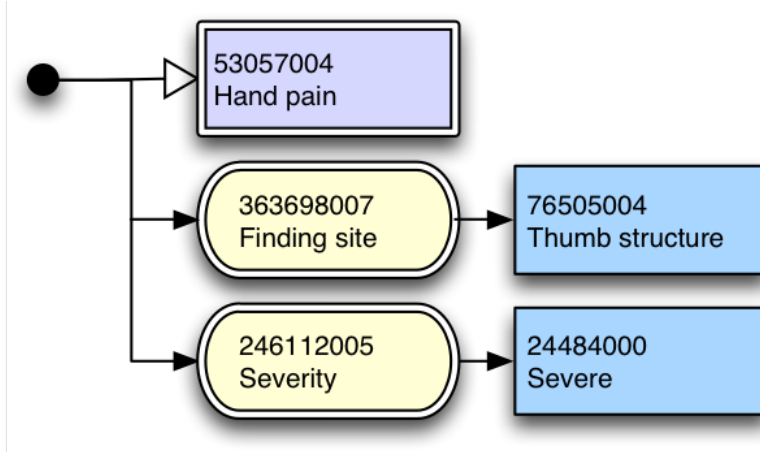

Figure 34 Redrawn Figure 21 from the SNOMED CT TIG section 4.2.2.3.3

Note that the redrawn expression diagram is distinguishable from a concept definition of "hand pain" - under the notation specified in this document concept definitions are rendered differently.

Figure 22 Nested refinement applied to a body site from the SNOMED CT Technical Implementation Guide section 4.2.2.3.3

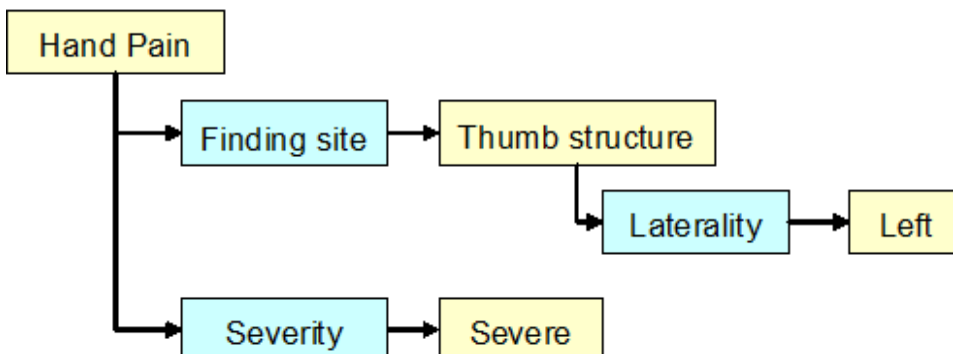

Figure 35 SNOMED CT TIG section 4.2.2.3.3 Figure 22  
Would be redrawn as

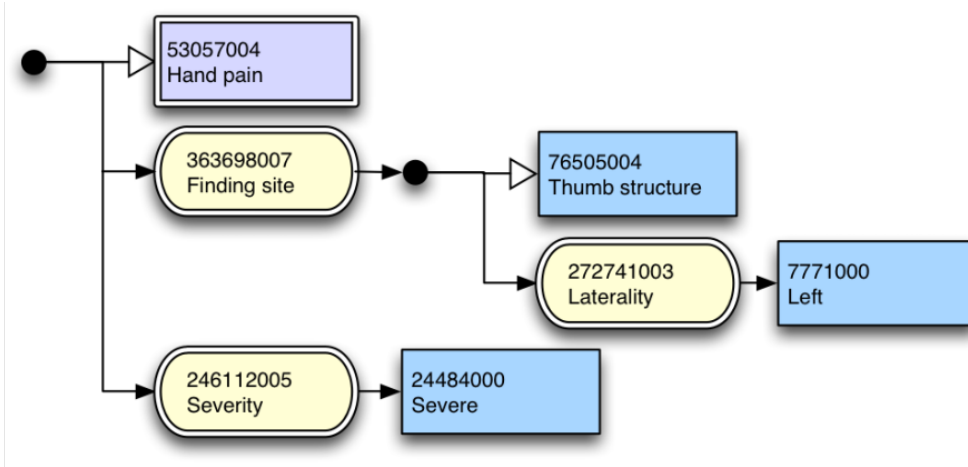

Figure 36 Redrawn Figure 22 from the SNOMED CT TIG section 4.2.2.3.3  
 Figure 23 Grouped refinement from the SNOMED CT Technical Implementation Guide section 4.2.2.3.3

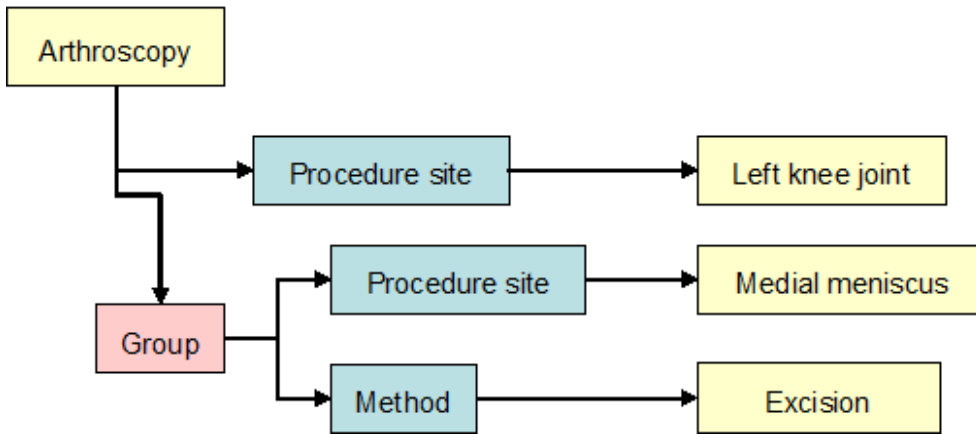

Figure 37 SNOMED CT TIG section 4.2.2.3.3 Figure 23  
 Would be redrawn as

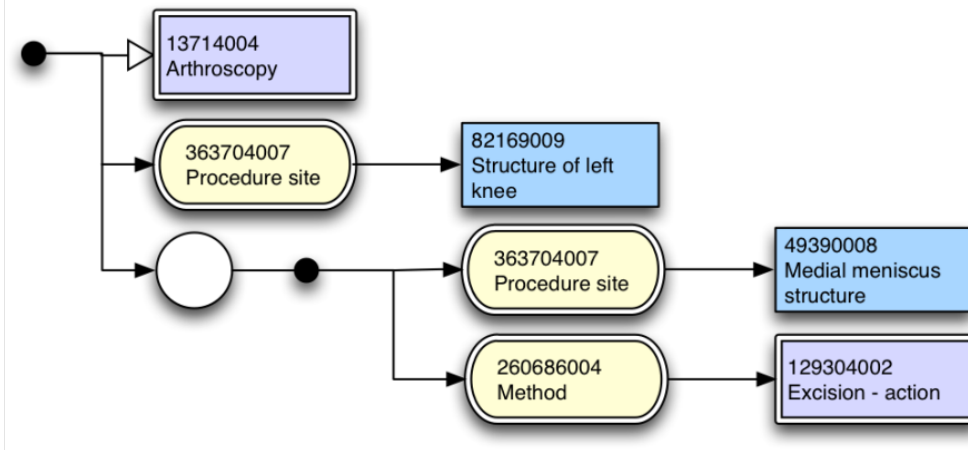

Figure 38 Redrawn Figure 23 from the SNOMED CT TIG section 4.2.2.3.3  
 Figure 24 An expression with two focus concepts from the SNOMED CT Technical Implementation Guide section 4.2.2.3.4

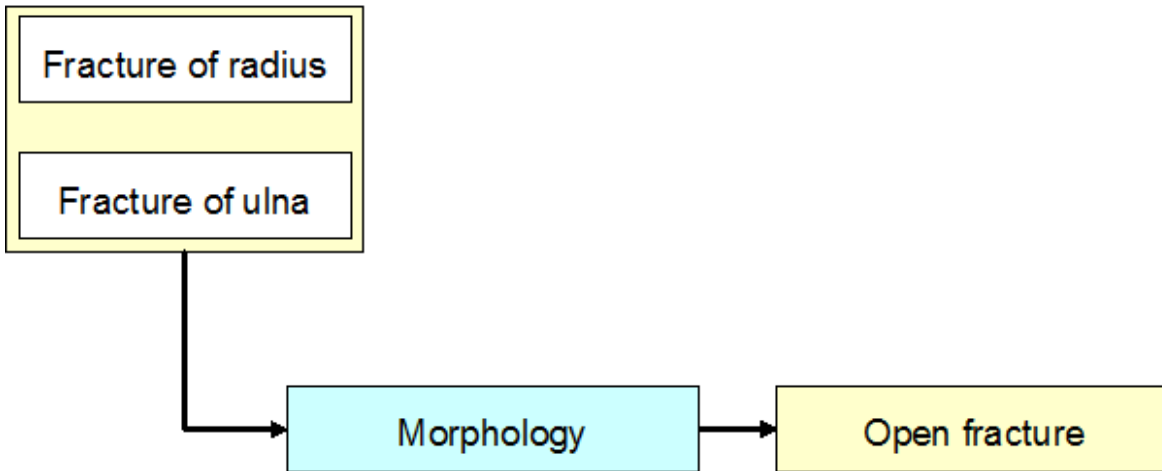

Figure 39 SNOMED CT section 4.2.2.3.4 Figure 24  
Would be redrawn as

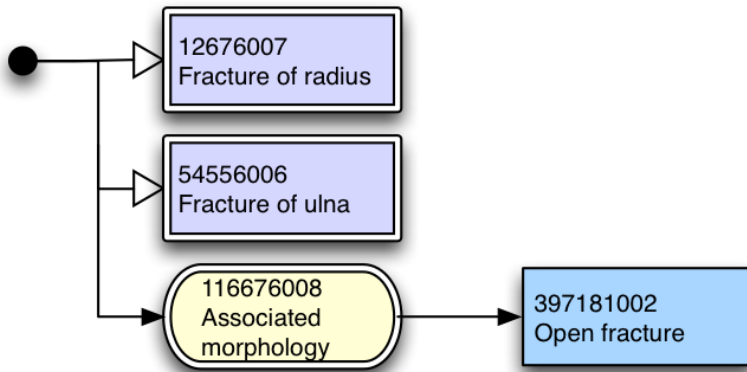

Figure 40 Redrawn Figure 24 from the SNOMED CT TIG section 4.2.2.3.4  
Figure 25 An alternative view of an expression with two focus concepts from the SNOMED CT Technical Implementation Guide section 4.2.2.3.4

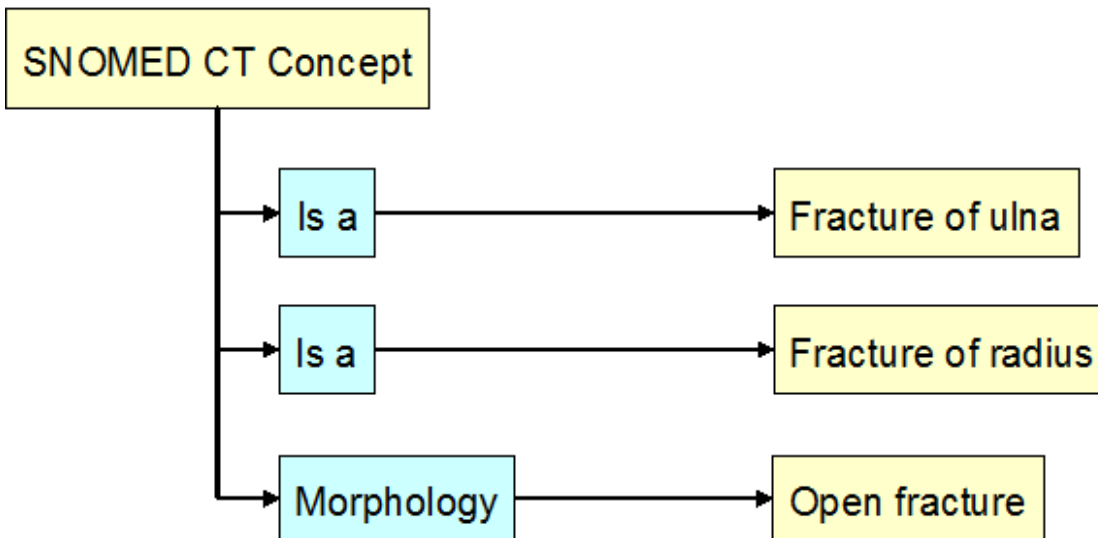

Figure 41 SNOMED CT TIG section 4.2.2.3.4 Figure 25  
Would be drawn little different to the previous example for Figure 24 An expression with two focus concepts as

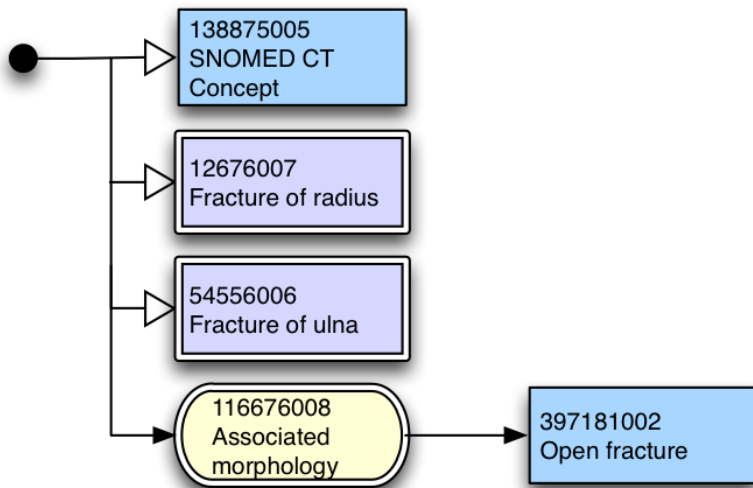

Figure 42 Redrawn Figure 25 from SNOMED CT TIG section 4.2.2.3.4

Figure 26 Family history of a specific type of severe allergy to nuts as close-to-user form expression from the SNOMED CT Technical Implementation Guide section 4.2.2.3.5

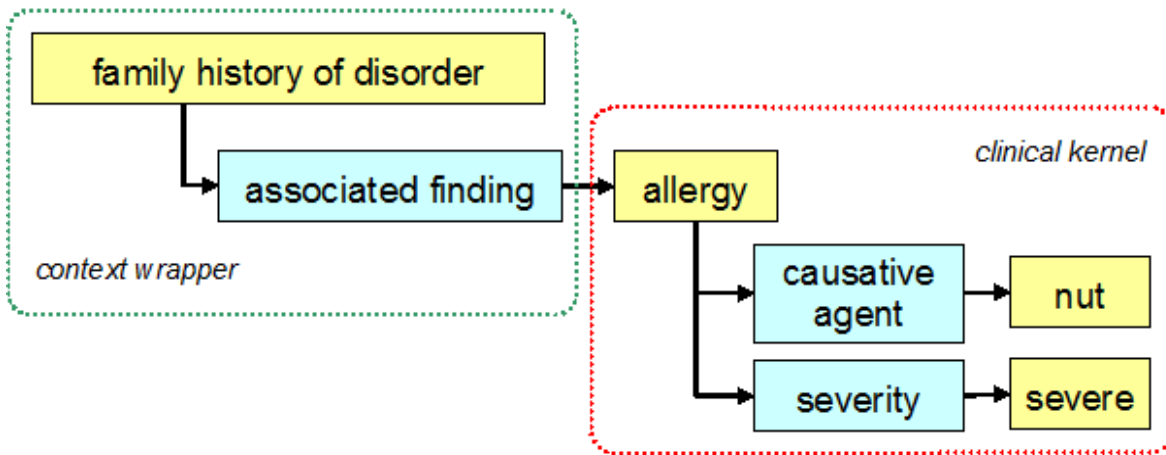

Figure 43 SNOMED CT TIG section 4.2.2.3.5 Figure 26 Would be redrawn as

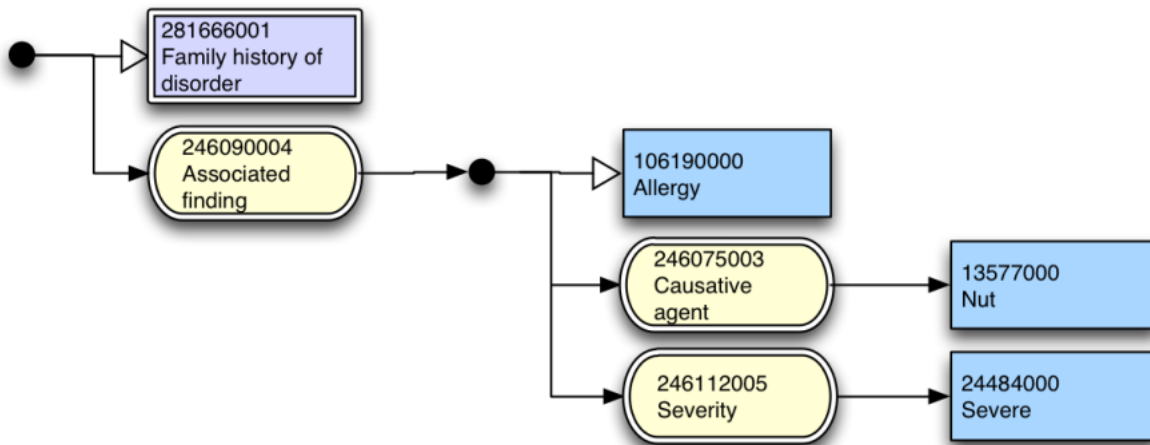

Figure 44 Redrawn Figure 26 from the SNOMED CT TIG section 4.2.2.3.5

Figure 27 Family history of severe allergy to nuts represented by using a context wrapper expression from the SNOMED CT Technical Implementation Guide section 4.2.2.3.5

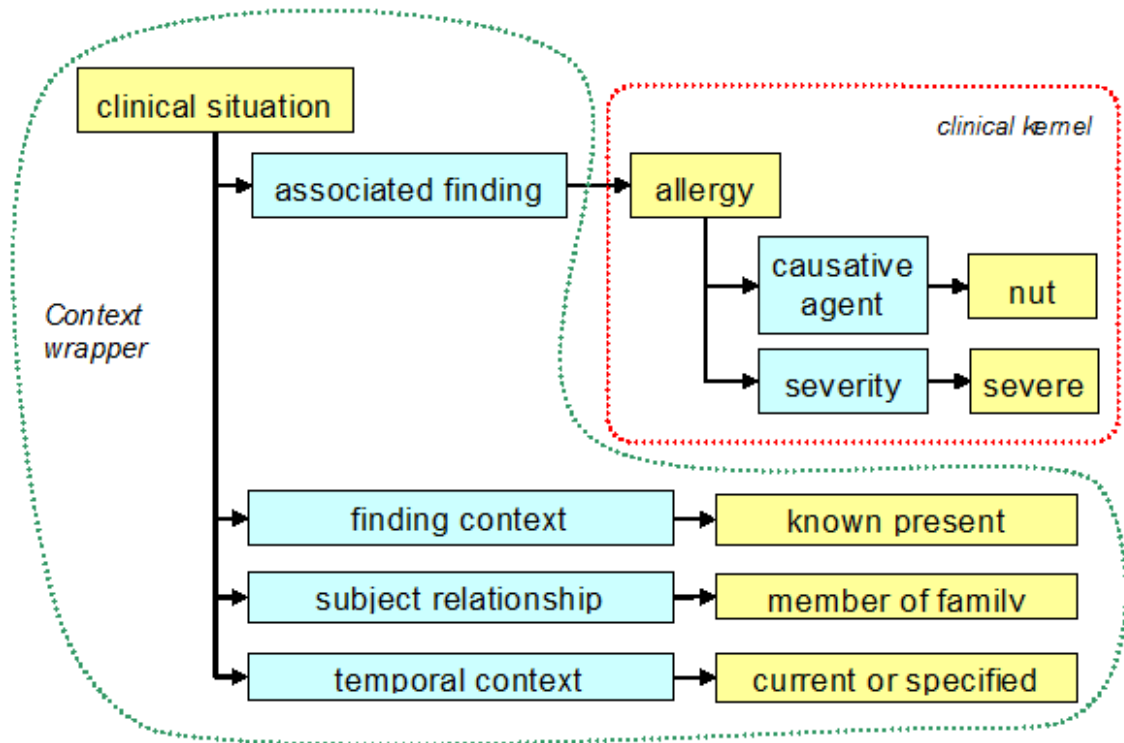

Figure 45 SNOMED CT TIG section 4.2.2.3.5 Figure 27  
Would be redrawn as

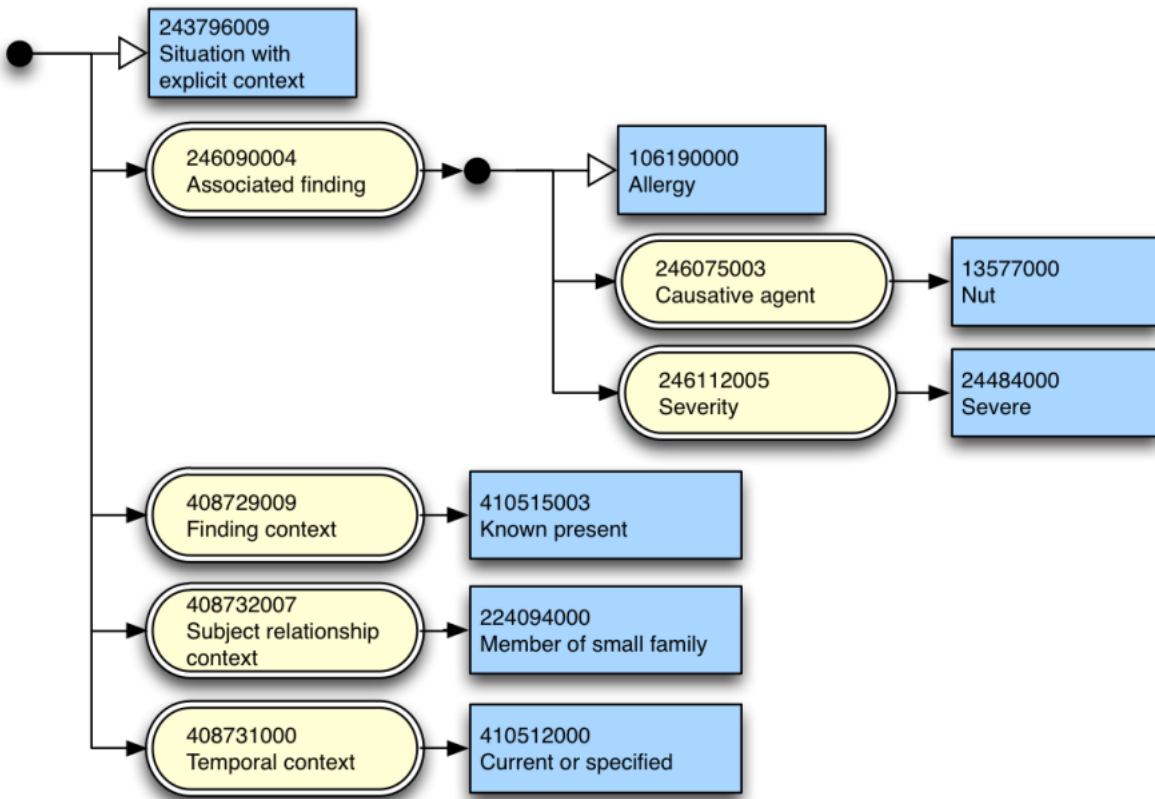

Figure 46 Redrawn Figure 27 from SNOMED CT TIG section 4.2.2.3.5

